

Product Datasheet - Technical Specifications



More information in our Web-Shop at ► www.meilhaus.com

Your contact

Technical and commercial sales, price information,
quotations, demo/test equipment, consulting:

Tel.: +49 - (0)81 41 - 52 71-0

E-Mail: sales@meilhaus.com

Meilhaus Electronic GmbH
Am Sonnenlicht 2
82239 Alling/Germany

Tel. +49 - (0)81 41 - 52 71-0 E-
Mail sales@meilhaus.com

Mentioned company and product names may be registered trademarks of the respective companies. Errors and omissions excepted. © Meilhaus Electronic.

R&S® ESSENTIALS

R&S® RTB 2 SERIES OSCILLOSCOPE

Power of ten for every task, everyday

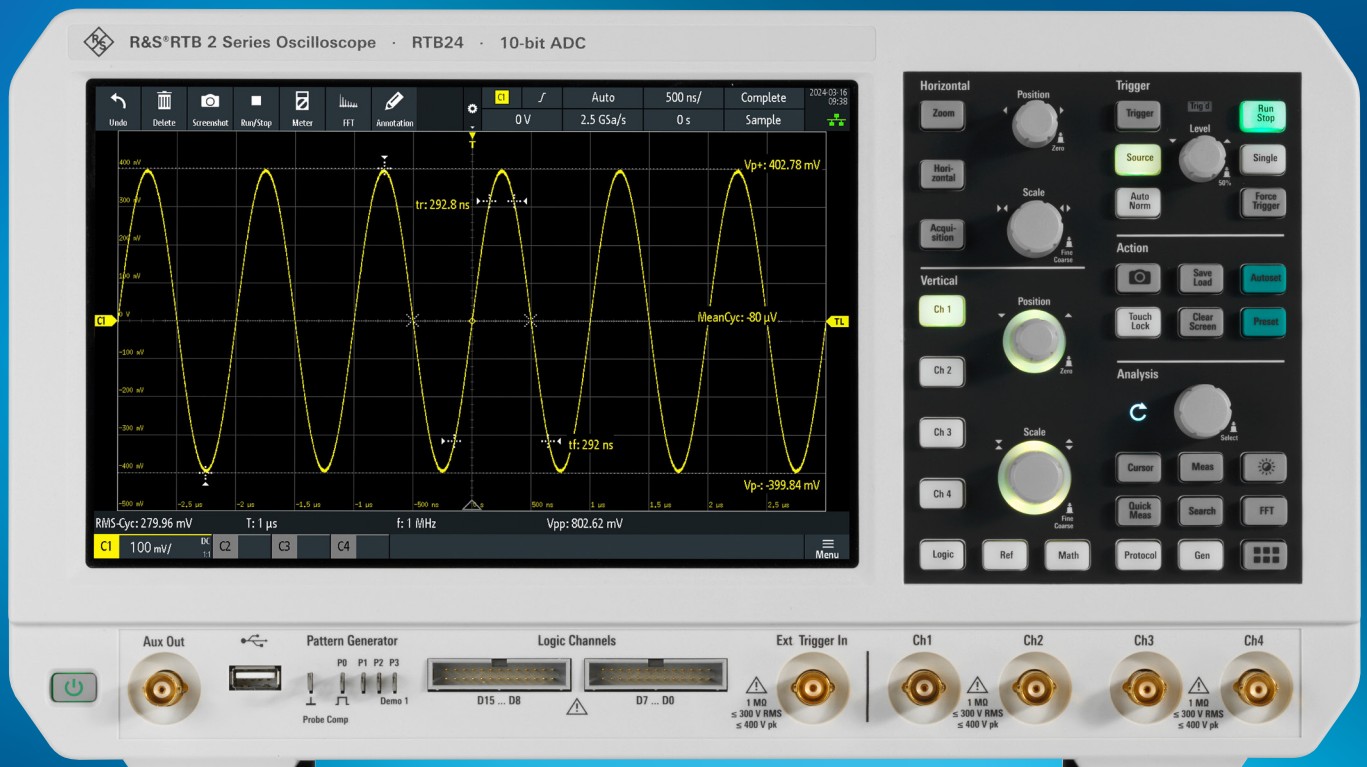

Product Brochure
Version 01.00

ROHDE & SCHWARZ

Make ideas real



POWER OF TEN FOR EVERY TASK, EVERYDAY

R&S®RTB 2 series oscilloscopes combine the power of ten with smart operating concepts to make them a perfect general-purpose tool for students, hobbyists, technicians and engineers. The R&S®RTB 2 series is the follow up to the high-performance R&S®RTB2000 oscilloscope. Try one in the lab and see the difference.

Power of ten:

- ▶ 10-bit ADC
- ▶ 10 Mpoints memory
- ▶ 10.1" capacitive touchscreen
- ▶ 10 s boot time
- ▶ 10-in-1 instruments



2-channel model



4-channel model

70/100/200/300 MHz bandwidth

Up to 2.5 Gsample/s sample rate

Up to 260 Mpoints in segmented mode

MSO-ready

WHY ENGINEERS LOVE ROHDE & SCHWARZ OSCILLOSCOPES

- ▶ A trusted, global company with a long-standing commitment to customers, quality and continuous innovation
- ▶ The newest oscilloscope portfolio from 60 MHz to 16 GHz
- ▶ Superior intuitive user interface and front panel to increase productivity
- ▶ Best-in-class time-domain and frequency-domain measurements

WHY THE R&S®RTB 2 SERIES

- ▶ **10-in-1 instrument:** oscilloscope, protocol analyzer, logic analyzer, waveform and pattern generator, digital multimeter, frequency response analyzer, spectrum analyzer, counter and mask tester

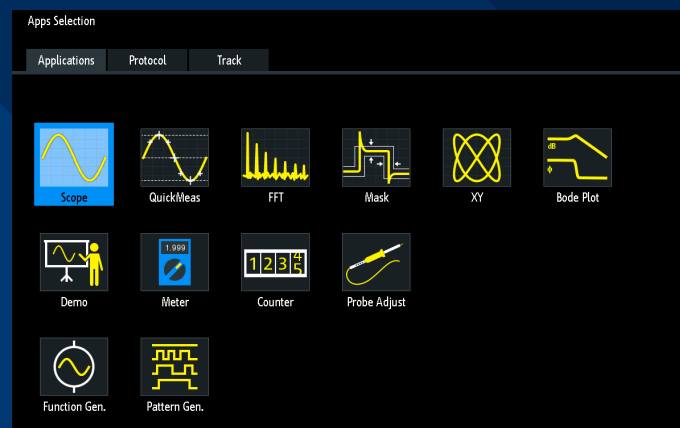

SEE SIGNAL DETAILS IN THE PRESENCE OF LARGE SIGNALS

10-bit vertical resolution

The R&S®RTB 2 includes a customized Rohde & Schwarz 10-bit A/D converter and is a four-fold improvement over conventional 8-bit A/D converters. The higher resolution generates sharper waveforms and reveals more details that would otherwise be missed.

The R&S®RTB 2 oscilloscope incorporates low-noise frontends and state-of-the-art A/D converters. High-resolution mode further reduces noise by applying a filter across contiguous samples.

Low noise: full measurement bandwidth down to 1 mV/div

The R&S®RTB 2 oscilloscope has excellent sensitivity down to 1 mV/div. Traditional oscilloscopes can only have such input sensitivity with software based magnification or limiting bandwidth.

Need to see large signals? The variable gain amplifier accepts up to 5 V/div. Use a 10:1, 100:1 or even higher attenuation probe to safely measure larger signals.

10-bit A/D converter: uncovers even small signal details

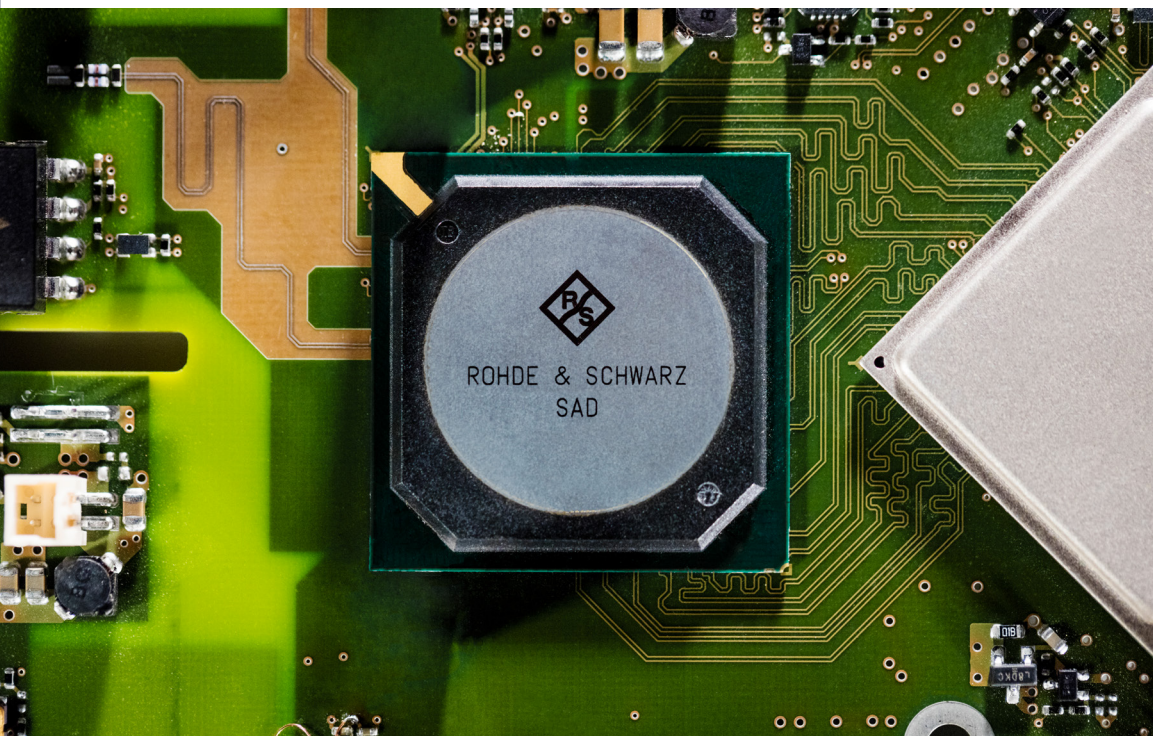
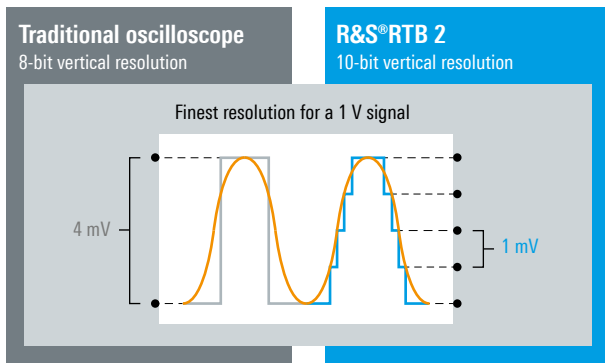

The Rohde & Schwarz designed 10-bit A/D converter ensures highest signal fidelity at highest resolution

CAPTURE MORE TIME

DEEP STANDARD MEMORY

Deep memory as an insurance policy

Along with bandwidth and sample rates, memory depth is the most important factor when determining oscilloscope troubleshooting capacity. More acquisition memory lets oscilloscopes capture more time. More memory lets oscilloscopes retain the maximum sample rate and bandwidth even with slower timebase settings.

$$\text{Time captured} = (\text{memory depth}) / (\text{sample rate})$$

Maintain fast sample rates with slow timebase settings

Ever adjusted your oscilloscope timebase to capture longer periods of time, pressed stop, then zoomed in to find the signal details are not quite right? This is the aliasing problem common to oscilloscopes with shallow memory capacity. The deep R&S®RTB 2 memory enables longer time captures at full sample rates.

Standard segmented memory

Use segmented memory to capture signals separated by inactivity. Examples include laser pulses, serial bus activity and RF pulses. R&S®RTB 2 series oscilloscopes have a segmented memory to capture signals over long observation periods of up to 13000 segments and up to 260 Mpoints total (13000 segments x 20 kpoints per segment).

Standard history capability

Press stop and use the history mode to see previously captured acquisitions. All measurement and analysis tools are available in the history mode, including the serial bus decoding and automatic measurements. Turn on persistence to see a waveform overlay of all captured events. Turn on measurements with statistics to see measurement progression across the entire history.

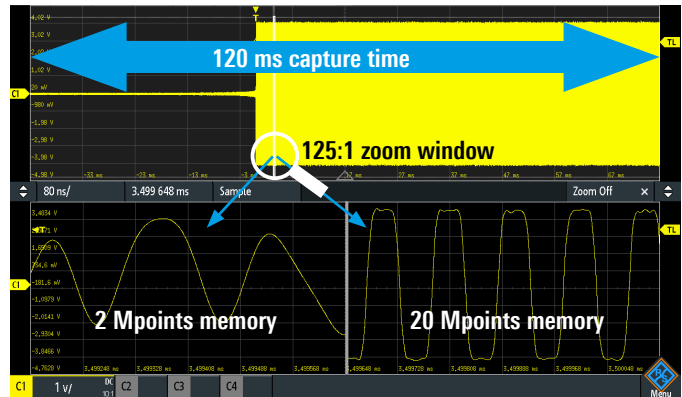

Traditional single-shot acquisition

$$\text{Total acquisition time} = \text{memory depth} / \text{sample rate}$$

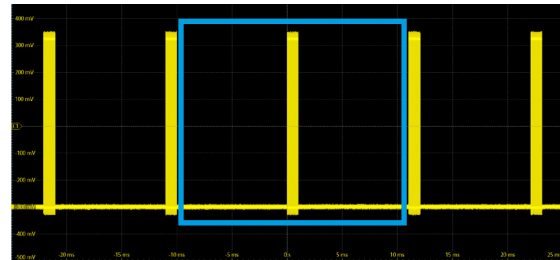

Segment

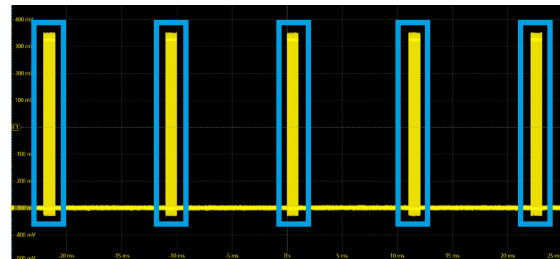

Segmented memory acquisition

$$\text{Acquisition time per segment} = \text{memory depth} / \# \text{ of segments}$$

FREQUENCY RESPONSE ANALYSIS

CREATING BODE PLOTS

Low-frequency response analysis

Use the R&S®RTB-K36 frequency response analysis option (Bode plot) for quick and easy low-frequency response analyses with your oscilloscope.

Characterize the frequency response for several electronic devices, including passive filters and amplifier circuits. The control loop response and power supply rejection ratio for switch mode power supplies can also be measured. The stimulus can be generated with a standard built-in waveform generator. By measuring the ratio of the stimulus signal relative to the DUT output signal at each test frequency, the oscilloscope logarithmically plots gain and phase.

The frequency response analysis option turns on the integrated waveform generator to create stimulus signals ranging from 10 Hz to 25 MHz. Measuring the ratio of the stimulus signal to the DUT output signal at each test frequency, the oscilloscope also logarithmically plots gain and phase.

The R&S®RT-ZP1X 38 MHz bandwidth 1:1 passive probe reduces probe noise for the best signal-to-noise ratio (SNR) for weak signals.

Features and functions

Create up to 16 generator amplitude output level steps to optimize the SNR at different frequencies when measuring CLR and PSRR.

Define the number of points per decade to trade off measurement speed versus resolution.

The oscilloscope display shows analog waveforms and the resulting Bode plots in parallel.

The table of measurement results displays the gain and phase for each frequency tested. Analyze with markers and the result table. Save screenshots, result tables or both to a USB drive.

The R&S®RTB-K36 frequency response analysis (Bode plot) option characterizes the frequency response of a variety of electronic devices, including passive filters and amplifier circuits



THE BEST CHOICE FOR EDUCATION

Ready for the teaching lab

Let students prepare for the working world with an oscilloscope used by companies in the industry. Use the password-protected education mode to disable automatic functions, such as autoset, so students can learn the fundamental concepts. On your PC, type in the IP address and use the built-in web server to easily show the oscilloscope display in a classroom or over a network.

X-in-1 integration saves space and money

The R&S®RTB 2 gives students and educators an oscilloscope plus logic and protocol analyzer, waveform and pattern generator, Bode analysis, digital voltmeter, spectrum analyzer and counter. The compact design, quiet operation and small footprint save precious bench space in the lab.

Perfect instruments for everyday educational with broad functionality, rugged design, quiet operation and small footprint



FUN TO DRIVE

15-MINUTE LEARNING CURVE, INTUITIVE NAVIGATION

Multilingual support: choose among thirteen languages

Choose from English, German, French, Spanish, Italian, Portuguese, Czech, Polish, Russian, simplified and traditional Chinese, Korean and Japanese.



Navigate to any oscilloscope function using the menu key in the lower right corner of the touchscreen.

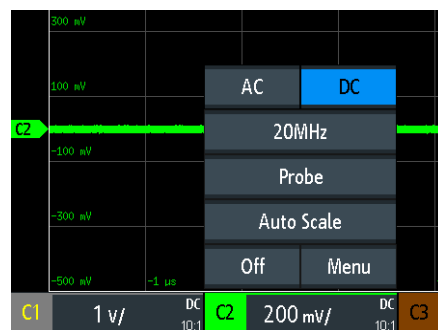

Touch any signal icons to bring up a short menu of common settings.

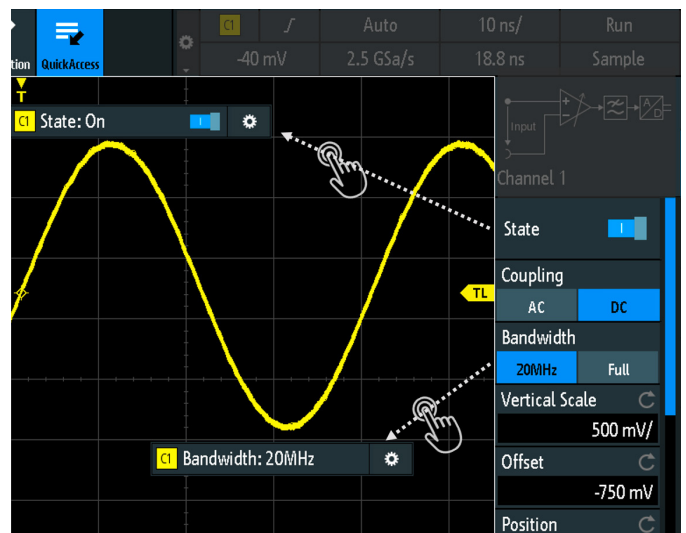

Add annotations to document screenshots including hand-drawn graphics.

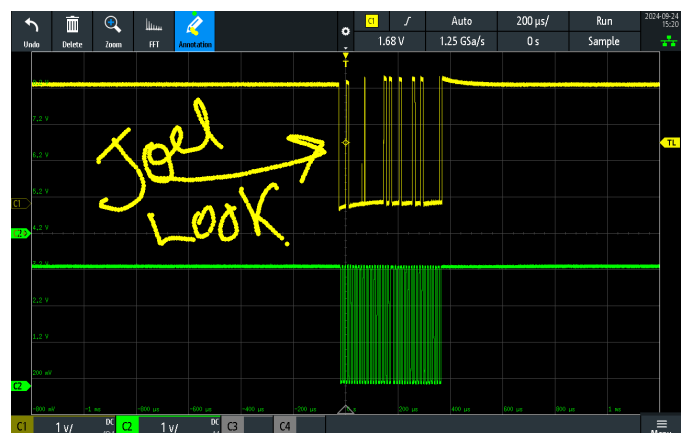

X-IN-1 OSCILLOSCOPE

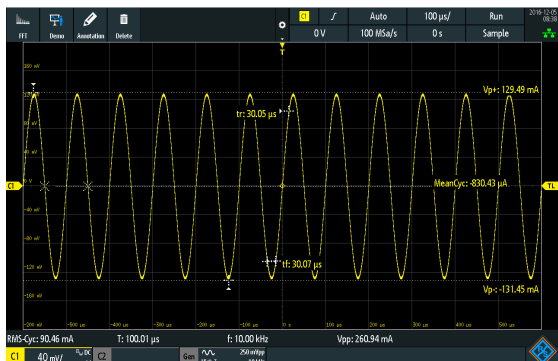

Oscilloscope

Get quick insight with the intuitive and powerful oscilloscope function. The superior sample rate, memory, depth and ADC resolution, make the R&S®RTB 2 oscilloscope a leader in its class.

Standard tools are included for quick results, such as QuickMeas, mask tests, FFT, math, cursors and automatic measurements, including statistics.

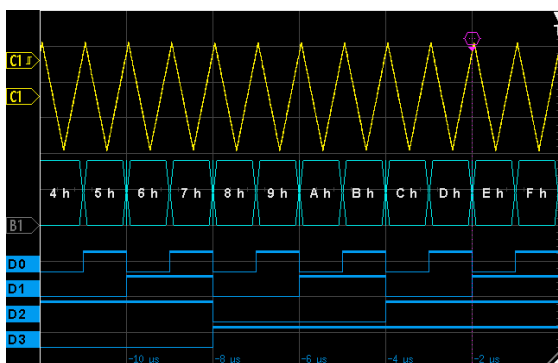

Logic analyzer

Every R&S®RTB 2 oscilloscope is MSO-ready and can connect two logic probes to turn every R&S®RTB 2 into an intuitive MSO with 16 additional digital channels. The oscilloscope captures and analyzes signals from analog and embedded digital design components – synchronously and time-correlated.

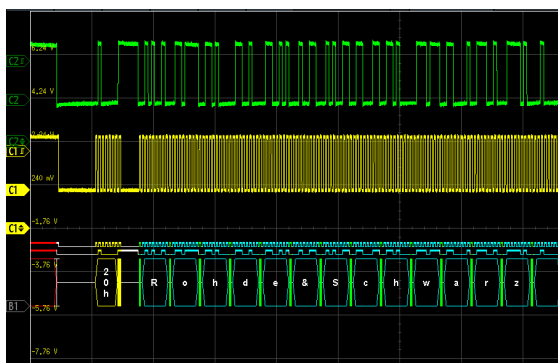

Serial bus protocol analyzer

Protocols such as I²C, SPI, UART/RS-232, CAN and LIN frequently transfer control messages between integrated circuits. The R&S®RTB 2 has versatile options for protocol-specific triggering and decoding of serial interfaces.

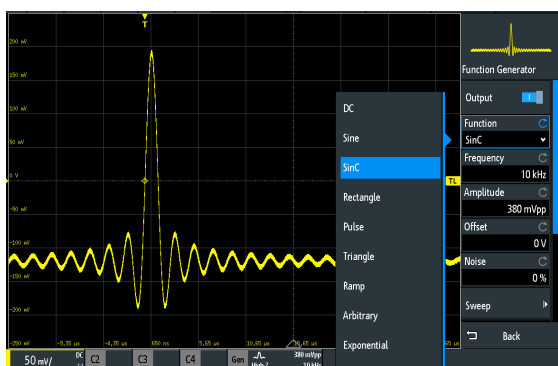

Waveform and pattern generator

Standard on all R&S®RTB 2 instruments, the integrated waveform (25 MHz) and pattern generator (up to 50 Mbit/s) provides circuit stimulus to emulate missing circuits. Or take advantage of educational opportunities for waveform and pattern generation. Waveforms and patterns can be imported as CSV files or copied from oscilloscope waveforms. Add noise to generated waveforms to simulate unfriendly environments. Predefined I²C, SPI, UART and CAN/LIN patterns are available for pattern generation. Select a counter or enter patterns manually.

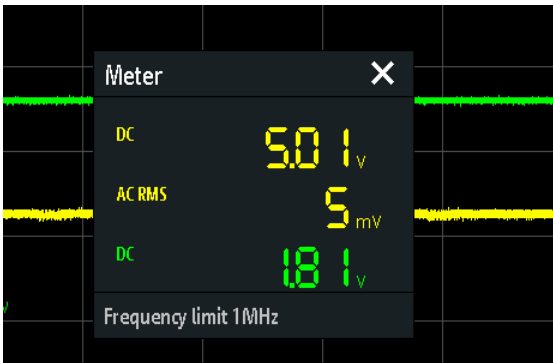

Digital voltmeter

The R&S®RTB 2 features a three-digit digital voltmeter (DVM). Choose from DC, AC + DC (RMS) and AC (RMS).

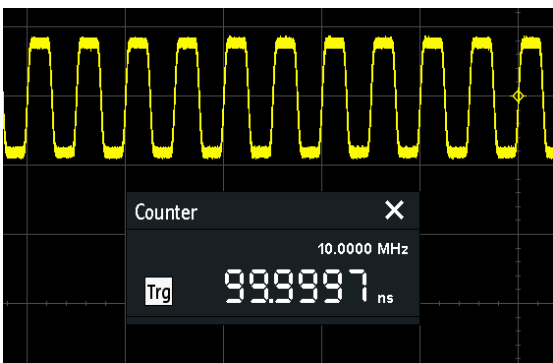

Counter

Use the standard integrated counter to measure frequencies, such as the trigger rate.

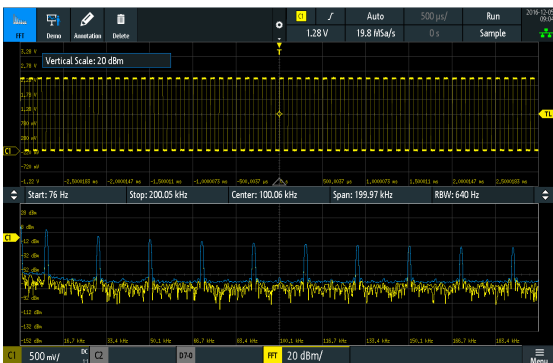

FFT (spectrum analyzer)

The FFT function on the R&S®RTB 2 is activated at the push of a button. Use it as a spectrum analyzer by entering center frequency and span. Autoset and cursor measurements can be used to measure the fast frequency-domain measurements.



Mask test mode

Use mask tests to quickly reveal whether a specific signal is within defined tolerance limits. Mask testing provides statistical pass/fail evaluations. Quickly identify violations and gather pass/fail statistics. Each violation can generate a pulse output at the AUX-OUT connector.

LAN AND USB CONNECTIVITY

USB and LAN I/O

All R&S®RTB 2 oscilloscopes come with both LAN and USB type B ports located on the rear panel (see area outlined in blue in the photo) for versatile control and data management options. The USB type B port simplifies file sharing with the easy transfer of saved waveforms, screenshots and measurement data directly to a connected PC. The connection eliminates the need for additional software and makes it easier to work with captured data and have it readily available for analysis and documentation. The combination of USB and LAN I/O on the R&S®RTB 2 series is a powerful, flexible and user-friendly interface for both local and remote oscilloscope control.



MTP connectivity

The R&S®RTB 2 oscilloscopes have seamless media transfer protocol (MTP) connectivity to PCs via the USB host port. File sharing and data management are exceptionally easy. Once connected, the oscilloscope appears on your PC as an additional drive, like a USB flash drive. This intuitive function gives lets users directly access files stored on an oscilloscope without additional drivers or complex setup procedures.

Transferring data is a simple drag & drop process with MTP. Screenshots can be quickly opened in popular applications such as PowerPoint or Word, streamlining report generation by eliminating the need to manually save and import images. Similarly, waveform data can be easily transferred into Excel or other data analysis tools for immediate processing and quick post-measurement analysis. Extra steps are eliminated and workflows sped up so that captured data is instantly ready for further use. The R&S®RTB 2 oscilloscope MTP function makes users much more efficient by simplifying the handling of measurement data and screenshots, The oscilloscope is vital tool for both quick documentation and in-depth analysis.

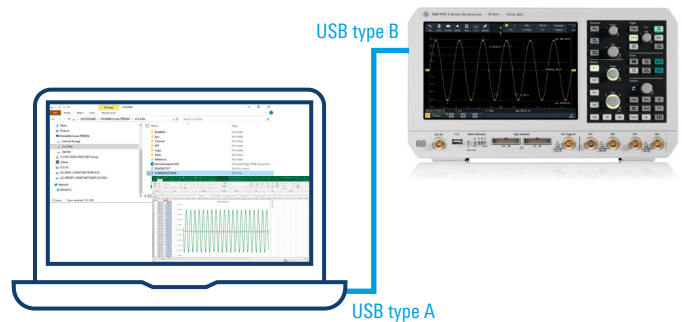
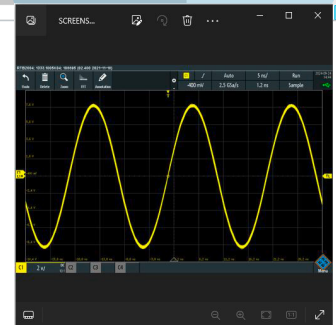
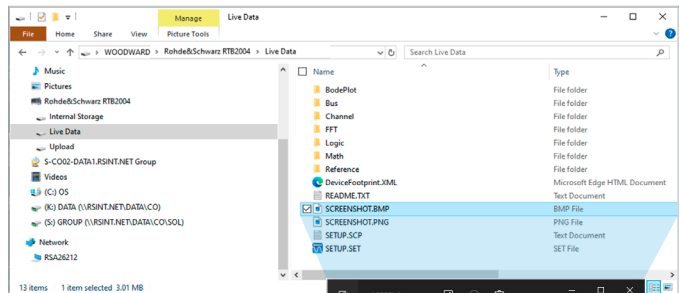

LAN connectivity

The R&S®RTB 2 oscilloscopes are engineered for a very efficient and user-friendly remote control experience through advanced LAN connectivity. By simply entering the IP address for an oscilloscope into any web browser, users can immediately access the complete instrument interface. Oscilloscope parameters can be adjusted and monitored in real time with a virtual front panel, effectively eliminating the need for physical interaction with the instrument. The virtual front panel is very useful in remote testing scenarios where physical access to the oscilloscope is limited or impractical.

The LAN interface supports standard commands for programmable instruments (SCPI) for robust program control that integrates seamlessly with automated test setups. Using SCPI commands is critical for incorporating the oscilloscope into larger automated systems or when precise, remote instrument operation is required. The built-in web interface helps both with comprehensive controls but also simplifies data management. Users can capture screenshots and transfer measurement data directly to a PC without additional software or manual data entry. Streamlining data sharing and reporting enhances productivity and makes it easy to swiftly document and analyze results from a remote location. The combination of intuitive web based controls, versatile programming capabilities and efficient data entry with an LAN connection makes the R&S®RTB 2 series a powerful and adaptable solution for any laboratory.

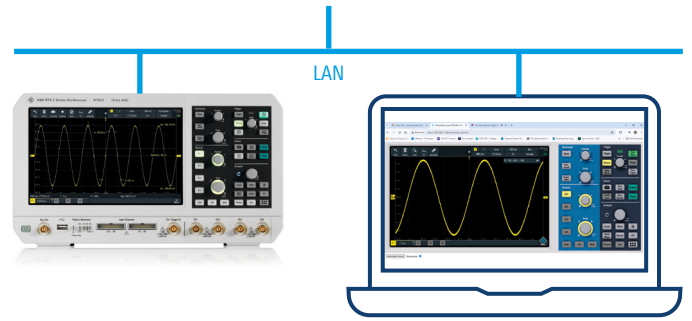

10.1" HIGH-RESOLUTION CAPACITIVE TOUCH

Quick access to important tools

- ▶ Drag & drop use of analysis tools
- ▶ Toolbar for access to functions
- ▶ Sidebar for intuitive configuration of functions

Easily customizable waveform display

- ▶ Configurable display
- ▶ Resizable waveform areas
- ▶ Scales labeled on all axes

Integrated waveform and pattern generator up to 50 Mbit/s

- ▶ Output of sine, square/pulse, ramp and noise waveforms
- ▶ Output of arbitrary waveform files and 4-bit signal patterns

10-second boot-up time

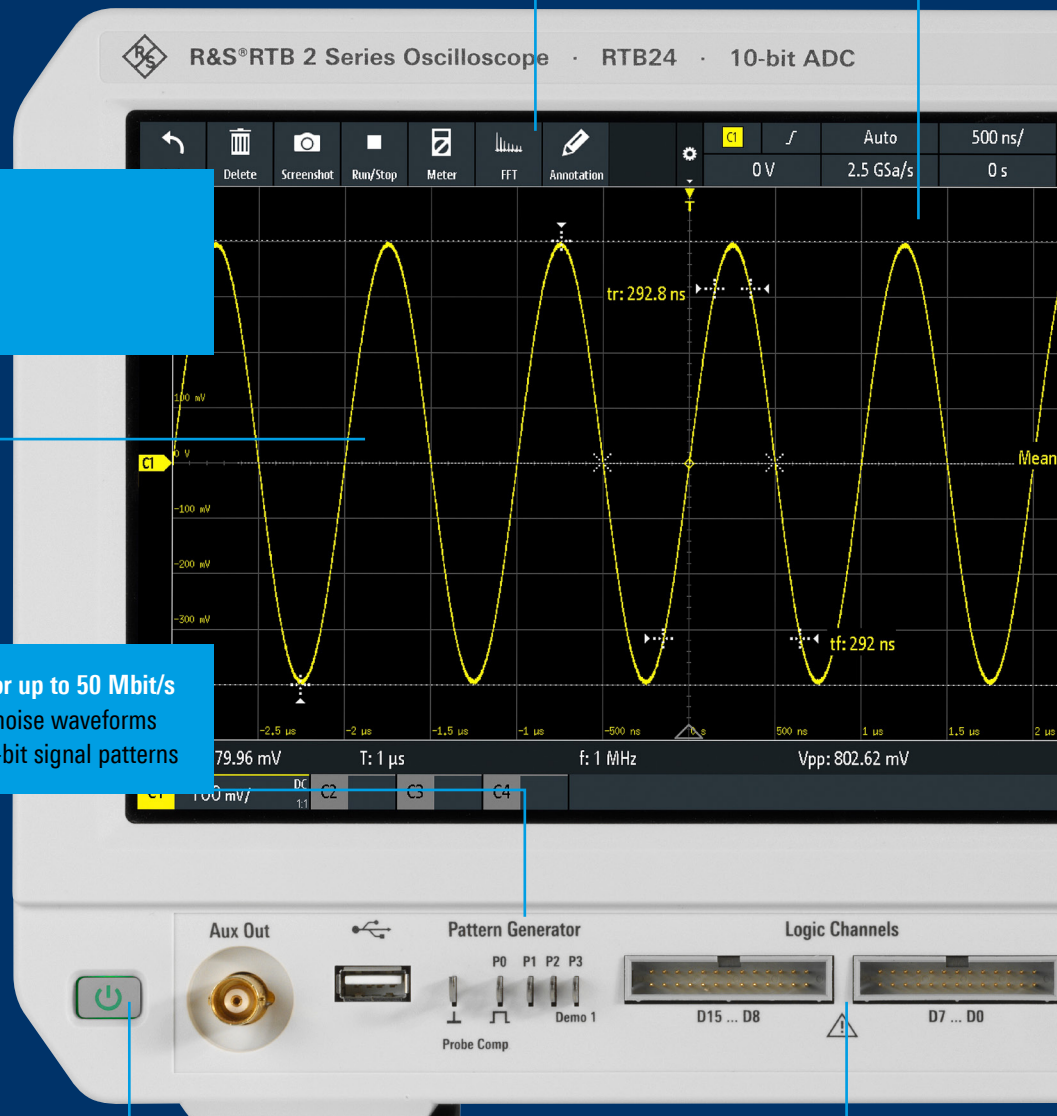

TOUCHSCREEN WITH GESTURE SUPPORT

10.1" high-resolution capacitive touchscreen with gesture support

- ▶ Gesture support for scaling and zooming
- ▶ More display area than similar oscilloscopes
- ▶ See a sharper image with more pixels: 1280 × 800 pixel resolution



Documentation of results at the push of a button

- ▶ Documentation as a screenshot or of instrument settings

Autoset function

- ▶ Automatic selection of vertical, horizontal and trigger settings for optimal viewing of active signals
- ▶ Setting of FFT parameters

Color-coded controls indicate the selected channel

QuickMeas: results at the push of a button

- ▶ Graphical display of key measurement results for the active signal

Integrated logic analyzer (MSO-ready)

- ▶ Add 16 additional digital channels
- ▶ Get time-correlated analysis of analog and digital signals

OSCILLOSCOPE PORTFOLIO



	R&S®RTH1000	R&S®RTC1000	R&S®RTB 2	R&S®RTM3000
Vertical system				
Bandwidth ¹⁾	60/100/200/350/500 MHz	50/70/100/200/300 MHz	70/100/200/300 MHz	100/200/350/500 MHz/1 GHz
Number of channels	2 plus DMM/4	2	2/4	2/4
Vertical resolution; system architecture	10 bit; 16 bit	8 bit; 16 bit	10 bit; 16 bit	10 bit; 16 bit
V/div, 1 MΩ	2 mV to 100 V	1 mV to 10 V	1 mV to 5 V	500 μV to 10 V
V/div, 50 Ω	–			500 μV to 1 V
Digital channels	8	8	16	16
Horizontal system				
Sampling rate per channel (in Gsample/s)	1.25 (4-channel model); 2.5 (2-channel model); 5 (all channels interleaved)	1; 2 (2 channels interleaved)	1.25; 2.5 (2 channels interleaved)	2.5; 5 (2 channels interleaved)
Maximum memory (per channel; 1 channel active)	125 kpoints (4-channel model); 250 kpoints (2-channel model); 500 kpoints	1 Mpoints; 2 Mpoints	10 Mpoints; 20 Mpoints	40 Mpoints; 80 Mpoints
Segmented memory	standard, 50 Mpoints	–	standard, 320 Mpoints	option, 400 Mpoints
Acquisition rate (in waveforms/s)	50 000	10 000	50 000 (300 000 in fast segmented memory mode)	64 000 (2 000 000 in fast segmented memory mode ²⁾)
Trigger				
Types	digital	analog	analog	analog
Sensitivity	–	–	at 1 mV/div: > 2 div	at 1 mV/div: > 2 div
Analysis				
Mask test	tolerance mask	tolerance mask	tolerance mask	tolerance mask
Mathematics	elementary	elementary	basic (math on math)	basic (math on math)
Serial protocols triggering and decoding ¹⁾	I ² C, SPI, UART/RS-232/RS-422/RS-485, CAN, LIN, CAN FD, SENT	I ² C, SPI, UART/RS-232/RS-422/RS-485, CAN, LIN	I ² C, SPI, UART/RS-232/RS-422/RS-485, CAN, LIN	I ² C, SPI, UART/RS-232/RS-422/RS-485, CAN, LIN, I ² S, MIL-STD-1553, ARINC429
Applications ^{1), 2)}	high-resolution frequency counter, advanced spectrum analysis, harmonics analysis, user scripting	digital voltmeter (DVM), component tester, fast Fourier transform (FFT)	digital voltmeter (DVM), fast Fourier transform (FFT), frequency response analysis	power, digital voltmeter (DVM), spectrum analysis and spectrogram, frequency response analysis
Compliance testing ^{1), 2)}	–	–	–	–
Display and operation				
Size and resolution	7" touchscreen, 800 × 480 pixel	6.5", 640 × 480 pixel	10.1" touchscreen, 1280 × 800 pixel	10.1" touchscreen, 1280 × 800 pixel
General data				
Dimensions in mm (W × H × D)	201 × 293 × 74	285 × 175 × 140	390 × 220 × 152	390 × 220 × 152
Weight in kg	2.4	1.7	2.5	3.3
Battery	lithium-ion, > 4 h	–	–	–

¹⁾ Upgradeable.

²⁾ Requires an option.



MXO 4	MXO 5/MXO 5C	R&S®RT06	R&S®RTP
200/350/500 MHz/1/1.5 GHz	100/200/350/500 MHz/1/2 GHz	600 MHz/1/2/3/4/6 GHz	4/6/8/13/16 GHz
4	4/8	4	4
12 bit; 18 bit	12 bit; 18 bit	8 bit; 16 bit	8 bit; 16 bit
500 µV to 10 V	500 µV to 10 V	1 mV to 10 V (HD mode: 500 µV to 10 V)	
500 µV to 1 V	500 µV to 1 V	1 mV to 1 V (HD mode: 500 µV to 1 V)	2 mV to 1 V (HD mode: 1 mV to 1 V)
16	16	16	16
2.5; 5 (2 channels interleaved)	5 on 4 channels; 2.5 on 8 channels (2 channels interleaved)	10; 20 (2 channels interleaved in 4 GHz and 6 GHz model)	20; 40 (2 channels interleaved)
standard: 400 Mpoints; max. upgrade: 800 Mpoints ²⁾	standard: 500 Mpoints max. upgrade: 1 Gpoints ²⁾	standard: 200 Mpoints/800 Mpoints; max. upgrade: 1 Gpoints/2 Gpoints	standard: 100 Mpoints/400 Mpoints; max. upgrade: 3 Gpoints
standard: 10000 segments; option: 1000000 segments	standard: 10000 segments; option: 1000000 segments	standard	standard
> 4500000	> 4500000 on 4 channels	1000000 (2500000 in ultra-segmented memory mode)	750000 (> 3000000 in ultra-segmented memory mode)
advanced (includes zone trigger), digital trigger (15 trigger types)	advanced (includes zone trigger), digital trigger (15 trigger types)	advanced (includes zone trigger), digital trigger (15 trigger types), high speed serial pattern trigger including 5 Gbps clock data recovery (CDR) ²⁾	advanced (includes zone trigger), digital trigger (14 trigger types) with real-time deembedding ²⁾ , high speed serial pattern trigger including 8/16 Gbps clock data recovery (CDR) ²⁾
0.0001 div, across full bandwidth, user controllable	0.0001 div, across full bandwidth, user controllable	0.0001 div, across full bandwidth, user controllable	0.0001 div, across full bandwidth, user controllable
		user configurable, hardware based	user configurable, hardware based
advanced (formula editor)	advanced (formula editor)	advanced (formula editor, Python interface)	advanced (formula editor, Python interface)
I ² C, SPI, UART/RS-232/RS-422/RS-485, CAN, CAN FD, CAN XL, LIN, SPMI, 10BASE-T1S, ARINC, SPMI, QUAD-SPI	I ² C, SPI, UART/RS-232/RS-422/RS-485, CAN, CAN FD, CAN XL, LIN, SPMI, 10BASE-T1S, 100BASE-T1, ARINC, SPMI, QUAD-SPI	I ² C, SPI, UART/RS-232/RS-422/RS-485, CAN, LIN, I ² S, MIL-STD-1553, ARINC429, FlexRay™, CAN FD, MIPI RFFE, USB 2.0/HSC, MDIO, 8b10b, Ethernet, Manchester, NRZ, SENT, MIPI D-PHY, SpaceWire, MIPI M-PHY/UniPro, CXPI, USB 3.1 Gen 1, USB-SSIC, PCIe 1.1/2.0, USB Power Delivery, Automotive Ethernet 100/1000BASE-T1	I ² C, SPI, UART/RS-232/RS-422/RS-485, SENT, CAN, LIN, CAN FD, MIL-STD-1553, ARINC 429, SpaceWire, USB 2.0/HSC/PD, USB 3.1 Gen 1/Gen 2/SSIC, PCIe 1.1/2.0/3.0, 8b10b, MIPI RFFE, MIPI D/M-PHY/UniPro, Automotive Ethernet 100/1000BASE-T1, Ethernet 10/100BASE-TX, MDIO, Manchester, NRZ
power, digital voltmeter (DVM), frequency response analysis	power, digital voltmeter (DVM), frequency response analysis	power, advanced spectrum analysis and spectrogram, jitter and noise decomposition, clock data recovery (CDR), I/Q data and RF analysis (R&S®VSE), deembedding, embedding, equalization, PAM-N, TDR/TDT analysis, advanced eye diagram	advanced spectrum analysis and spectrogram, jitter and noise decomposition, real-time deembedding, embedding, equalization, PAM-N, TDR/TDT analysis, I/Q data and RF analysis (R&S®VSE), advanced eye diagram
-		see specifications (PD 5216.1640.22)	see specifications (PD 3683.5616.22)
13.3" touchscreen, 1920 × 1080 pixel (Full HD)	for MXO 5 only: 15.6" touchscreen, 1920 × 1080 pixel (Full HD)	15.6" touchscreen, 1920 × 1080 pixel (Full HD)	13.3" touchscreen, 1920 × 1080 pixel (Full HD)
414 × 279 × 162	MXO 5: 445 × 314 × 154 MXO 5C: 445 × 105 × 405	450 × 315 × 204	441 × 285 × 316
6	MXO 5: 9 MXO 5C: 8.7	10.7	18
-	-	-	-

SPECIFICATIONS IN BRIEF

Specifications in brief		
Vertical system		
Number of channels	R&S®RTB22, R&S®RTB24	2, 4
Bandwidth (-3 dB)	R&S®RTB22/24 (with R&S®RTB-B2x1, R&S®RTB-B2x2 and R&S®RTB-B2x3 options)	70 MHz, 100 MHz, 200 MHz, 300 MHz
Rise time (calculated)	70 MHz, 100 MHz, 200 MHz, 300 MHz	5 ns, 3.5 ns, 1.75 ns, 1.15 ns
Input impedance		1 M Ω \pm 2% with 9 pF \pm 2 pF (meas.)
Input sensitivity	max. bandwidth in all ranges	1 mV/div to 5 V/div
DC gain accuracy	offset and position = 0, maximum operating temperature change of \pm 5°C after self-alignment	
	input sensitivity > 5 mV/div	\pm 1.5% of full scale
	input sensitivity \leq 5 mV/div	\pm 2% of full scale
ADC resolution		10 bit, up to 16 bit with high resolution mode
Acquisition system		
Maximum sampling rate		1.25 Gsample/s, 2.5 Gsample/s in interleaved mode
Acquisition memory		10 Mpoints, 20 Mpoints in interleaved mode
	with segmented memory	max. 262 Mpoints
Horizontal system		
Timebase range		1 ns/div to 500 s/div
Trigger system		
Trigger types	standard	edge, width, video (PAL, NTSC, SECAM, PAL-M, SDTV 576i, HDTV 720p, HDTV 1080i, HDTV 1080p), pattern, runt, rise time, fall time, serial bus, timeout, line
	included with serial bus options	I ² C, SPI, UART/RS-232/RS-422/RS-485, CAN/LIN
Analysis and measurement functions		
QuickMeas	at the push of a button, measurement values are continuously written onto the waveform	peak-to-peak voltage, pos. peak, neg. peak, rise time, fall time, mean value, RMS value, time, period, frequency
Waveform mathematics		addition, subtraction, multiplication, division, FFT
MSO option (R&S®RTB2-B1)		
Digital channels		16 (2 logic probes)
Maximum sample rate		1.25 Gsample/s
Acquisition memory		10 Msample
Waveform generator		
Resolution, sample rate		14 bit, 250 Msample/s
Amplitude	high Z, 50 Ω	20 mV to 5 V (V_{pp}), 10 mV to 2.5 V (V_{pp})
DC offset	high Z, 50 Ω	\pm 2.5 V, \pm 1.25 V
Signal forms frequency ranges	sine	0.1 Hz to 25 MHz
	pulse/rectangle	0.1 Hz to 10 MHz
	ramp/triangle	0.1 Hz to 1 MHz
	noise	max. 25 MHz
Arbitrary	sampling rate, memory depth	max. 10 Msample/s, 16 kpoints
General data		
Screen		10.1" WXGA TFT color display (1280 \times 800 pixel)
Interfaces		USB host with MTP, USB device, LAN, web server for remote display and operation
Audible noise	maximum sound level at a distance of 1.0 m	28.3 dB(A)
Dimensions	W \times H \times D	390 mm \times 220 mm \times 152 mm (15.4 in \times 8.66 in \times 5.98 in)
Weight		2.5 kg (5.5 lb)

► For more information, see the R&S®RTB 2 specification document (PD 3673.0734.22) available under www.rohde-schwarz.com.

FROM PRESALES TO SERVICE. AT YOUR DOORSTEP.

The Rohde & Schwarz network in over 70 countries ensures optimum on-site support by highly qualified experts.

User risks are reduced to a minimum at all project stages:

- ▶ Solution finding/purchase
- ▶ Technical startup/application development/integration
- ▶ Training
- ▶ Operation/calibration/repair



ORDERING INFORMATION

1 Choose 2-channel or 4-channel instrument

The base model is MSO-ready with 70 MHz bandwidth and the R&S®RTB-B6 arbitrary waveform generator, the R&S®RTB-K15 history and segmented memory option and power cord.

2 Add additional bandwidth

- ▶ 70 MHz (included in base model)
- ▶ 100 MHz
- ▶ 200 MHz
- ▶ 300 MHz

3 Add desired applications/options

Options and applications can be purchased individually or as a bundle.

R&S®RTB2-PK1 bundle

Includes I²C, SPI, UART, RS-232, CAN and LIN serial triggering and decoding and R&S®RTB-K36 frequency response analysis (Bode plot) option

Choose from the oscilloscope probes

Each R&S®RTB 2 comes standard with one R&S®RT-ZP03S passive probe per channel. The instrument is compatible with other Rohde&Schwarz and third-party probes that connect to a BNC interface.

Add logic probes (MSO)

R&S®RTB 2 is MSO-ready, which makes mixed signal capability a standard functionality of the oscilloscope. Just add R&S®RTB2-B1 option (two logic probes (MSO)) to use up to 16 digital channels.

2-channel model

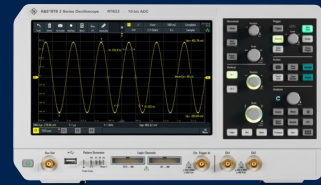

4-channel model

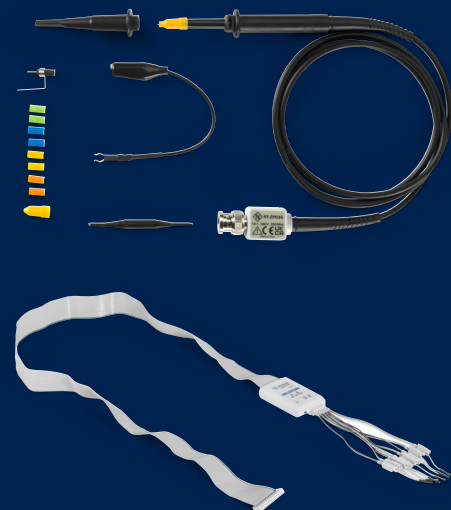
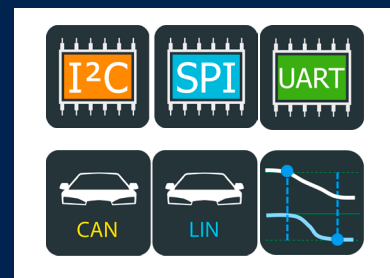
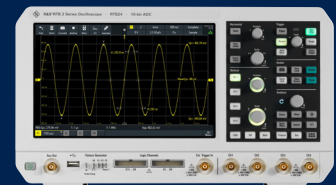

For more information, see the product brochure:
Probes and accessories for Rohde & Schwarz oscilloscopes (PD 3606.8866.12).

Designation	Type	Order No.
Choose your oscilloscope base model		
Oscilloscope, 70 MHz, 2 channels	R&S®RTB22	1333.1005.02
Oscilloscope, 70 MHz, 4 channels	R&S®RTB24	1333.1005.04
Base unit ¹⁾ (consists of R&S®RTB-B6 arbitrary waveform generator option, R&S®RTB-K15 history and segmented memory option and standard accessories (R&S®RT-ZP03S passive probe per channel, power cord)		
Choose your bandwidth upgrade		
Upgrade of R&S®RTB22 oscilloscopes to 100 MHz bandwidth	R&S®RTB-B221	1333.1163.02
Upgrade of R&S®RTB22 oscilloscopes to 200 MHz bandwidth	R&S®RTB-B222	1333.1170.02
Upgrade of R&S®RTB22 oscilloscopes to 300 MHz bandwidth	R&S®RTB-B223	1333.1186.02
Upgrade of R&S®RTB24 oscilloscopes to 100 MHz bandwidth	R&S®RTB-B241	1333.1257.02
Upgrade of R&S®RTB24 oscilloscopes to 200 MHz bandwidth	R&S®RTB-B242	1333.1263.02
Upgrade of R&S®RTB24 oscilloscopes to 300 MHz bandwidth	R&S®RTB-B243	1333.1270.02
Choose your options		
MSO, set of 2 logic probes, 300 MHz (+ 16 digital channels)	R&S®RTB2-B1	1801.8421.02
I ² C/SPI serial triggering and decoding	R&S®RTB-K1	part of R&S®RTB2-PK1
UART/RS-232/RS-422/RS-485 serial triggering and decoding	R&S®RTB-K2	part of R&S®RTB2-PK1
CAN/LIN serial triggering and decoding	R&S®RTB-K3	part of R&S®RTB2-PK1
Frequency response analysis (Bode plot)	R&S®RTB-K36	part of R&S®RTB2-PK1
Application bundle, consists of the following options: R&S®RTB-K1, R&S®RTB-K2, R&S®RTB-K3, R&S®RTB-K36	R&S®RTB2-PK1	1801.8438.02
Choose your additional probes		
Single-ended passive probes		
300 MHz, 10:1, 10 MΩ, 400 V, 12 pF	R&S®RT-ZP03S	1803.1001.02
500 MHz, 10 MΩ, 10:1, 300 V, 10 pF, 5 mm	R&S®RT-ZP05S	1333.2401.02
500 MHz, 10 MΩ, 10:1, 400 V, 9.5 pF	R&S®RT-ZP10	1409.7550.00
38 MHz, 1 MΩ, 1:1, 55 V, 39 pF	R&S®RT-ZP1X	1333.1370.02
High voltage single-ended passive probes		
250 MHz, 100:1, 100 MΩ, 850 V, 6.5 pF	R&S®RT-ZH03	1333.0873.02
400 MHz, 100:1, 50 MΩ, 1000 V, 7.5 pF	R&S®RT-ZH10	1409.7720.02
High voltage probes: passive		
400 MHz, 1000:1, 50 MΩ, 1000 V, 7.5 pF	R&S®RT-ZH11	1409.7737.02
Current probes		
20 kHz, AC/DC, 10 A/1000 A	R&S®RT-ZC02	1333.0850.02
100 kHz, AC/DC, 30 A	R&S®RT-ZC03	1333.0844.02
10 MHz, AC/DC, 150 A	R&S®RT-ZC10	1409.7750.02
100 MHz, AC/DC, 30 A	R&S®RT-ZC20	1409.7766.02
120 MHz, AC/DC, 5 A	R&S®RT-ZC30	1409.7772.02
Power supply for current probes	R&S®RT-ZA13	1409.7789.02
Logic probe (MSO)		
Active 8-channel logic probe	R&S®RT-ZL03	1333.0715.02
Probe accessories		
50 Ω feedthrough termination	R&S®HZ22	3594.4015.02
Probe pouch	R&S®RT-ZA19	1335.7875.02
Choose your accessories		
Front cover	R&S®RTB-Z1	1333.1728.02
Soft bag	R&S®RTB-Z3	1333.1734.02
Transit case	R&S®RTB-Z4	1335.9290.02
Rackmount kit	R&S®ZZA-RTB2K	1333.1711.02

¹⁾ Oscilloscope is MSO-ready.