

Product Datasheet - Technical Specifications



More information in our Web-Shop at ► www.meilhaus.com

Your contact

Technical and commercial sales, price information,
quotations, demo/test equipment, consulting:

Tel.: +49 - (0)81 41 - 52 71-0

E-Mail: sales@meilhaus.com

Meilhaus Electronic GmbH
Am Sonnenlicht 2
82239 Alling/Germany

Tel. +49 - (0)81 41 - 52 71-0 E-
Mail sales@meilhaus.com

Mentioned company and product names may be registered trademarks of the respective companies. Errors and omissions excepted. © Meilhaus Electronic.

10× the sensitivity of conventional probes



CT6701
DC to 120MHz, 5A MAX



CT6700
DC to 50MHz, 5A MAX

Observe low current waveforms of 1 mA

Connection image



A separate power supply is required when using the CT6700/CT6701.

Current probes are key to the successful design of electrical devices, medical instruments, and electronic parts. In combination with an oscilloscope or HIOKI MEMORY HiCORDER, probes are ideal for measuring currents with high accuracy and wide bandwidths, making them indispensable tools for evaluating current consumption and control current. In recent years, customers are seeking current probes with high sensitivity to increase the accuracy of design and verification. To further enhance our rich lineup of current probes, HIOKI now delivers two new, highly-sensitive current probes that can measure low level currents from 1 mA.

Analyze currents in finer detail



10x Sensitivity

Clearly observe even 1 mA waveforms

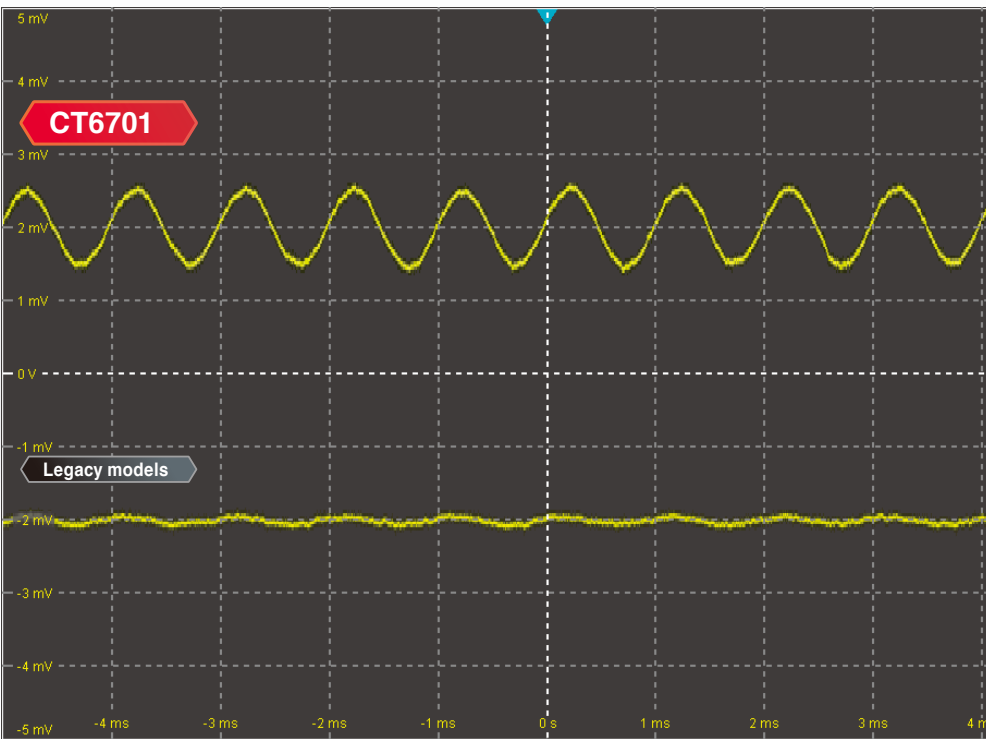

The output rate for the CT6700/CT6701 is 1 V/A. When 1 mA is measured, it can output 1 mV. This is ten times the sensitivity of our legacy*1 models. Now, even 1 mA waveforms can be clearly captured.*2

*1: CURRENT PROBE 3273-50/3276
Output rate 0.1 V/A, 30 A MAX

*2: When measuring low level currents, in addition to noise from the current probe itself, there is also influence from external noise or noise from the connected meter.

Input:
1 mAp-p, 1 kHz, sine wave
Oscilloscope:
Bandwidth 2 GHz
(Bandwidth limit 20 MHz), 1 mV/div



Improved S/N Ratio: Measure even the extremely low current signals buried in noise

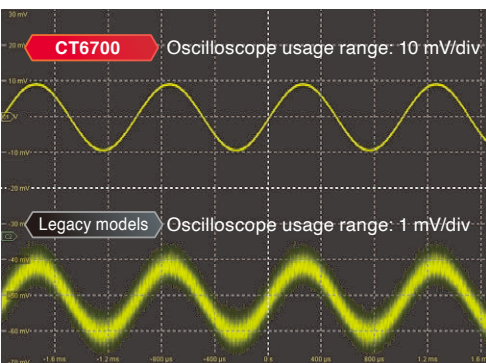

Input: 20 mAp-p, 1 kHz, sine wave
Oscilloscope: Bandwidth 2 GHz (No bandwidth limitation), 10 mV/div

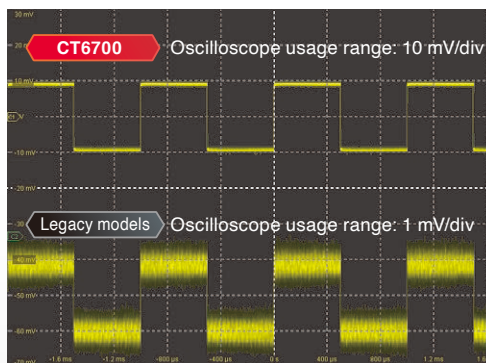

Input: 20 mAp-p, 1 kHz, square wave
Oscilloscope: Bandwidth 2 GHz (No bandwidth limitation), 10 mV/div

Low level currents can only be clearly captured by instruments that deliver a good S/N ratio. Because the output rate is now 1 V/A (10x than that of legacy models), you can observe waveforms even if the oscilloscope's range is 1/10 than that of legacy products. By allowing for range selection with leeway for the S/N ratio, you can clearly observe signals that previously were buried in noise.

Streamlining Measurement

Slim Sensor



The sensor has been redesigned, making it more compact and easier to handle, in a form that fits perfectly in your hand. The ergonomic structure is ideal for situations with complex electrical circuit design and wiring.

Warning Features

OVERLOAD Warning

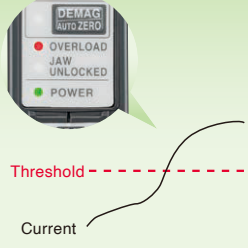

Threshold - - - - -
Current

JAW UNLOCKED Warning



The warning lamp will flash if a current exceeding the rating is input. "JAW UNLOCKED" will display and the warning lamp will light up if the sensor is unlocked when clamped.

Automatic Zero-Adjustment and Demagnetization in One Button



With the CT6700/CT6701, you can automatically perform the zero-adjustment, which must be done before use, by pressing a single button.

By pressing and holding the button for demagnetization, you can cancel an offset margin of error after measuring a large current.

One-touch Disconnection from the BNC Terminal

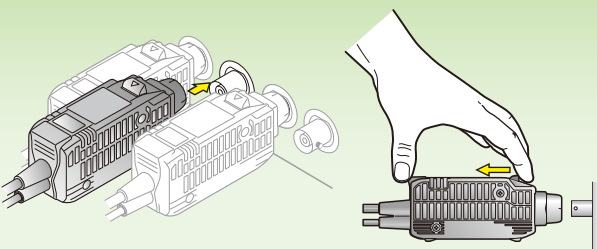

The BNC connector does not need to be rotated when connecting to an oscilloscope or recorder. Insert the connector until it automatically locks into place. To disconnect it, just pull the unlock lever toward you.

Built for Demanding Applications

Measure the current of automobile electronic parts

Observe control currents, which flow through automobile electronic parts such as compact motors, on the mA order.

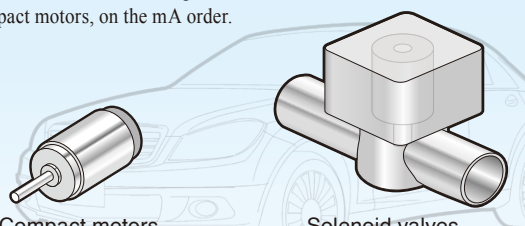

Compact motors Solenoid valves

Evaluate the current characteristics of circuit components

When testing for the correct functioning of built-in circuits, you can reliably catch noise waveforms with a wide frequency bandwidth.

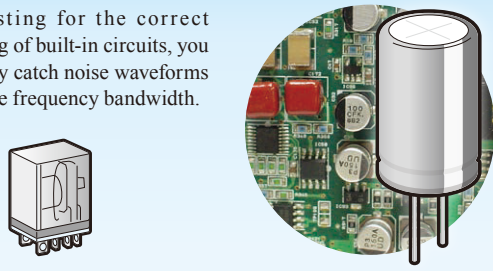

Relay control current Condenser current

Evaluate high-speed switching elements

Measure switching elements that drive devices such as LEDs and motors, including the ON/OFF response of semiconductors that operate at high speeds, ripple waveforms, and switching loss.

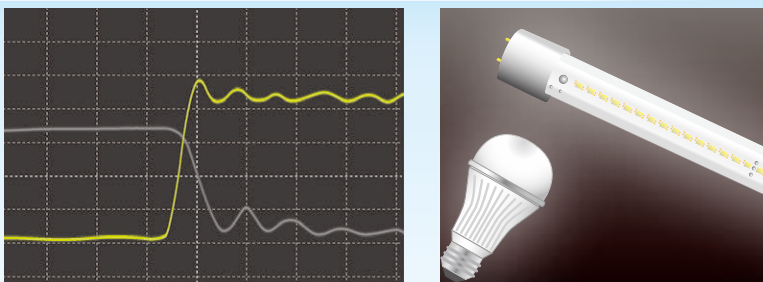

Waveform of an inverter when switched ON Evaluation of LED light driving circuits

Specifications

(Accuracy guaranteed for 1 year)

Model	CURRENT PROBE CT6700	CURRENT PROBE CT6701
Frequency range	DC to 50 MHz (-3dB) (Refer to the frequency characteristics graph below.)	DC to 120 MHz (-3dB) (Refer to the frequency characteristics graph below.)
Rise time (10% to 90%)	7.0 ns or less	2.9 ns or less
Maximum rated current	5 A rms (DC, and sine wave) (Refer to the frequency derating properties graph below.)	
Maximum peak current	±7.5 A peak (non-continuous)	
Diameter of measurable conductors	5 mm dia. or less	
Measurable conductors	Insulated conductors	
Output voltage rate	1 V/A	
Amplitude accuracy	Typical ±1%rdg. ±1 mV, ±3.0%rdg. ±1 mV (DC, 45 to 66 Hz sine wave, 0 to 5 A rms)	
Output resistance	50 Ω ±10% (DC)	
Noise	60 μA rms typical, 75 μA rms max (for 30 MHz band measuring instrument)	
Temperature coefficient for sensitivity	±2%rdg. or less (After automatic zero-adjustment with 50 Hz 5 A rms input, except at 23±5°C)	
Maximum rated power	3.2 VA (with continuous maximum input)	
Supply voltage	±12 V	
Operating temperature and humidity range	0 to +40°C, 80% RH or less (no condensation)	
Storage temperature and humidity range	-10 to +50°C, 80% RH or less (no condensation)	
Location for use	Indoor, pollution degree 2, altitude up to 2000 m	
Effect of external magnetic fields	20 mA max - DC and 60 Hz, magnetic field of 400 A/m	5 mA max - DC and 60 Hz, magnetic field of 400 A/m
Effect of radiated radio-frequency electromagnetic field	±10 mA max (at 3 V/m)	
Effect of conducted radio-frequency electromagnetic field	±10 mA max (at 3 V)	
DEMAG/AUTO ZERO function	Demagnetization, automatic zero-adjustment	
JAW UNLOCKED detection	LED lights up when the opening mechanism of the sensor head is unlocked.	
OVERLOAD detection	LED flashes to warn that the input is in excess of ratings	
Accuracy warranty period	1 year (Opening/closing up to 10,000 times)	
Cord lengths	Sensor cord: 1.5 m (4.92 ft), Power cord: 1.0 m (3.28 ft)	
External dimensions and mass	Sensor: 155 mm (6.10 in)W x 18 mm (0.71 in)H x 26 mm (1.02 in)D, Terminator: 29 mm (1.14 in)W x 83 mm (3.27 in)H x 40 mm (1.57 in)D, Mass: 250 g (8.8 oz)	
Accessories	Instruction manual, Carrying case	

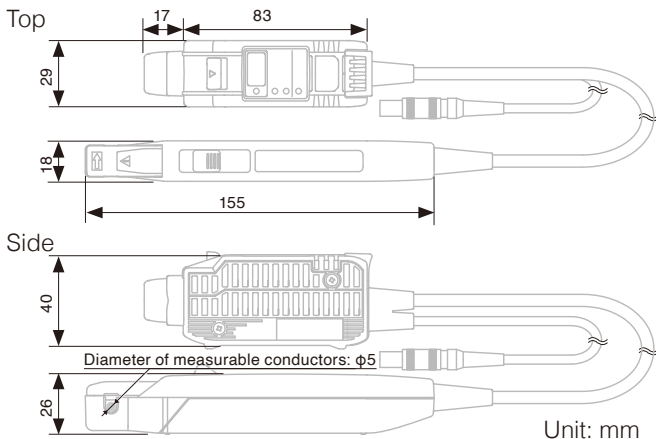
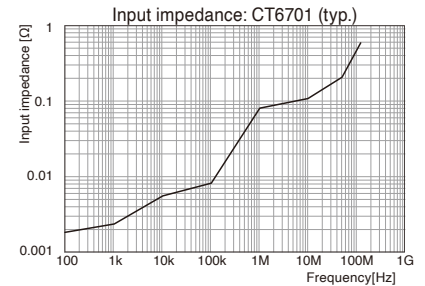
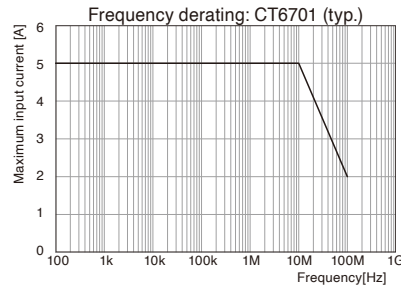
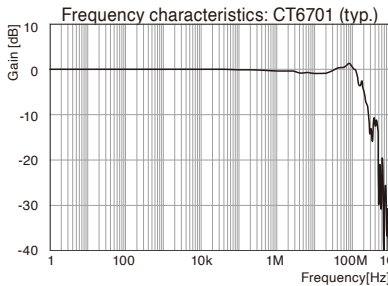
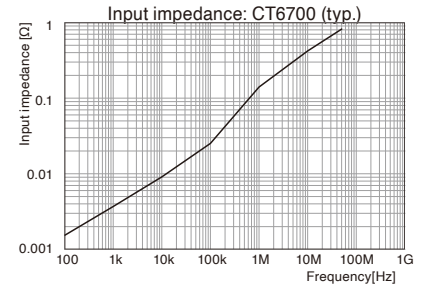
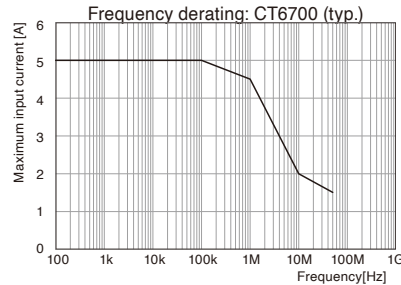
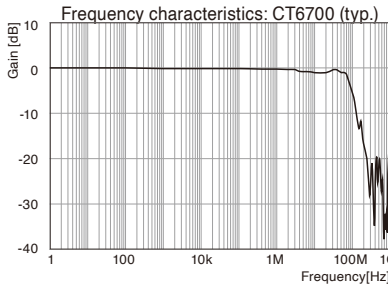

Model: CURRENT PROBE CT6700, CT6701

Model No. (Order Code)	CT6700	CT6701
Frequency range	DC to 50MHz	DC to 120MHz

A separate power supply is required when using the CT6700/CT6701.

<p>POWER SUPPLY 3269 Supports up to 4 current probes</p>	<p>POWER SUPPLY 3272 Supports 2 current probes</p>
--	--

*About the 3272 Power Supply
When using CT6700/CT6701 and a different sensor simultaneously, please note that you may not be able to use two sensors at once depending on the current consumption. Please check the specifications of the corresponding sensor.

Note: Company names and product names appearing in this brochure are trademarks or registered trademarks of various companies.

